

T5404 / T5604  
STEEL / ACIER

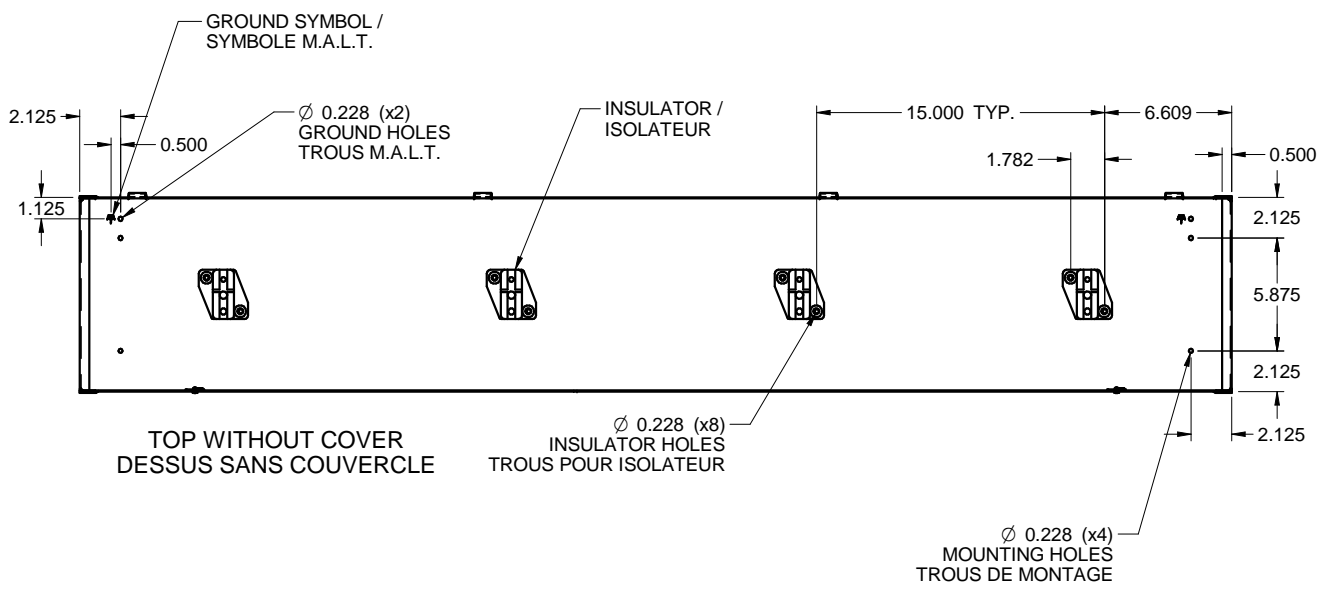
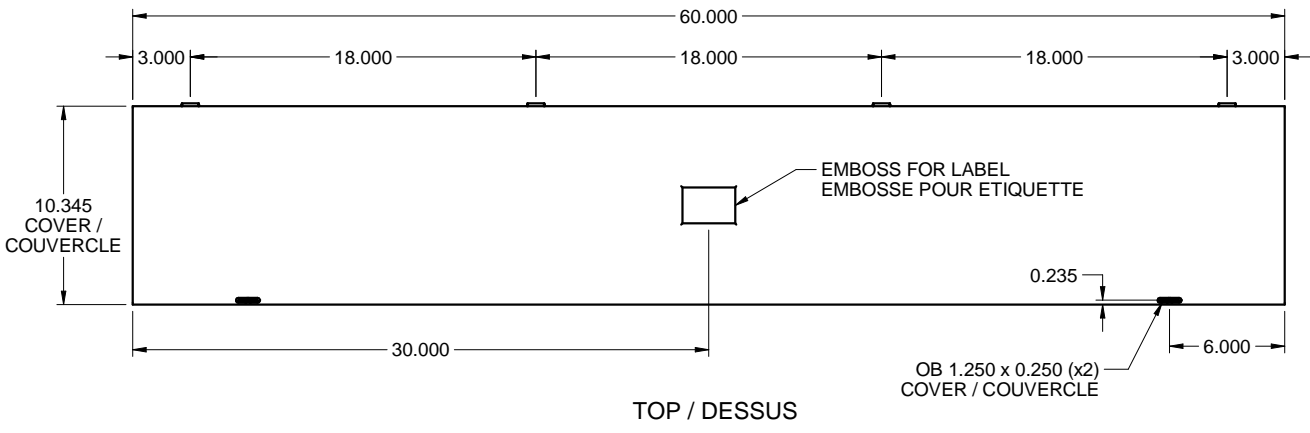
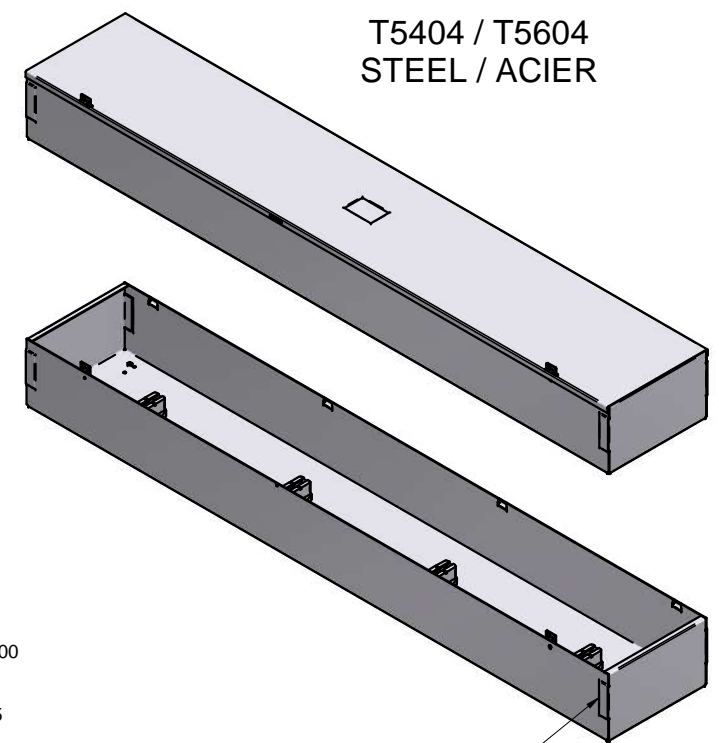

EMBOSS FOR SPOTWELD  
EMBOSSÉ POUR SOUDURE PAR POINT

REMOVABLE PADLOCK /  
PROVISION POUR CADENAS  
RETRACTABLE

FORMED HINGES /  
PENTURES FORMÉES

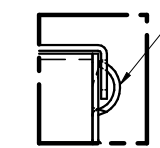
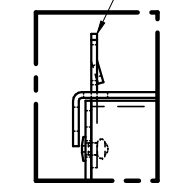

DETAIL B

DETAIL A

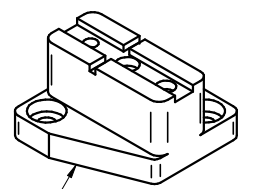
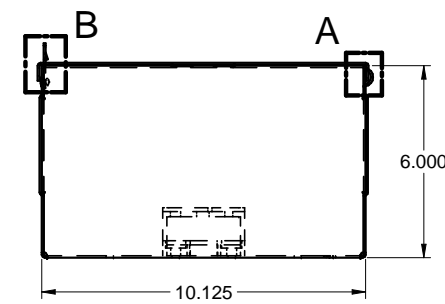
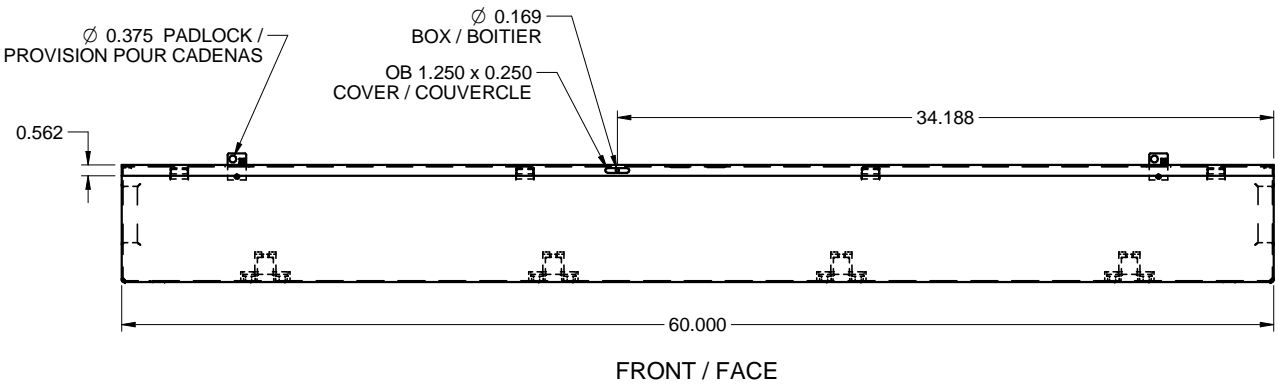

INSULATOR #BEL33  
ISOLATEUR #BEL33