

T474 / T4104
STEEL / ACIER

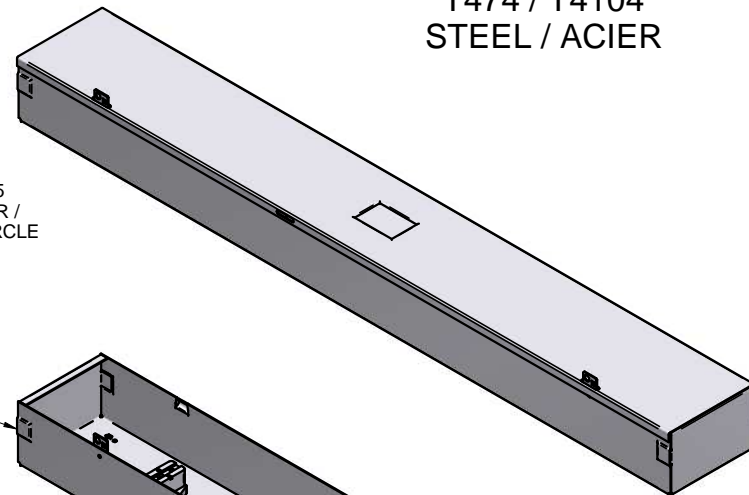

EMBOSS FOR SPOTWELD
EMBOSE POUR SOUDURE PAR POINT

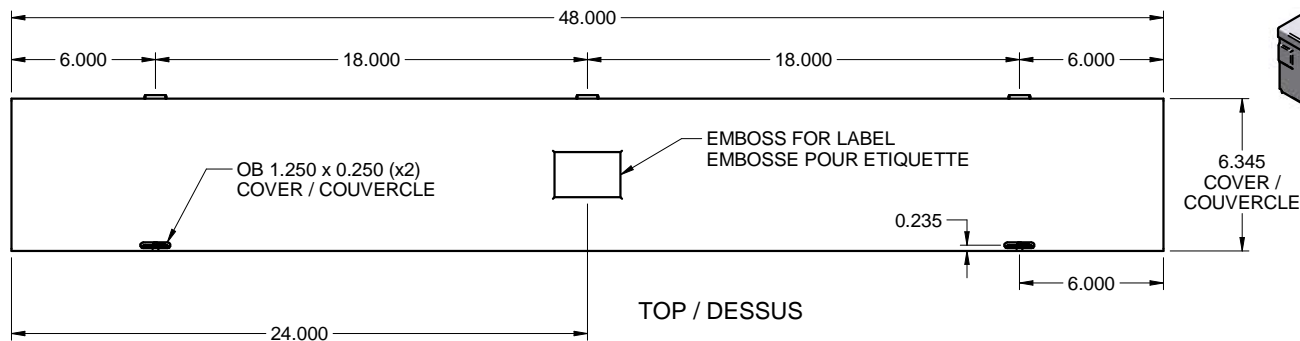
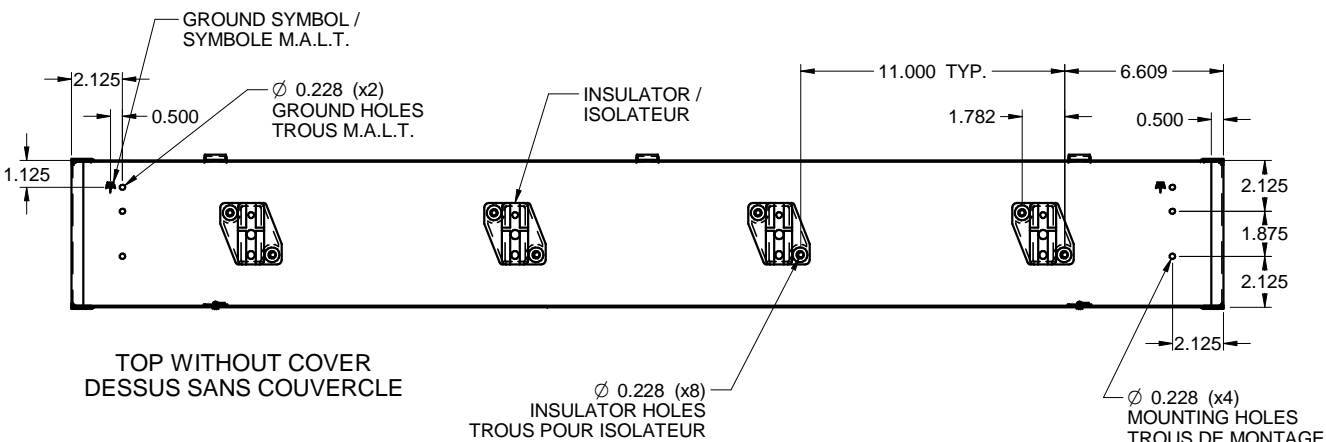

REMOVABLE PADLOCK /
PROVISION POUR CADENAS
RETRACTABLE

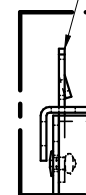

DETAIL B

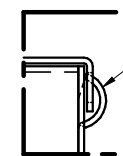

DETAIL A

FORMED HINGES /
PENTURES FORMÉES

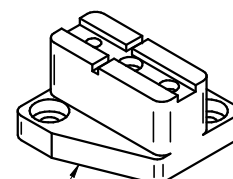
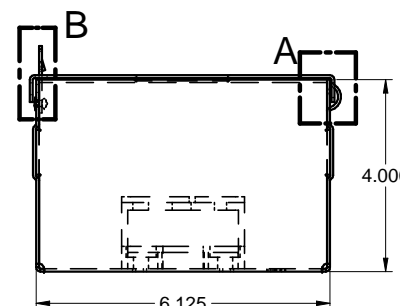
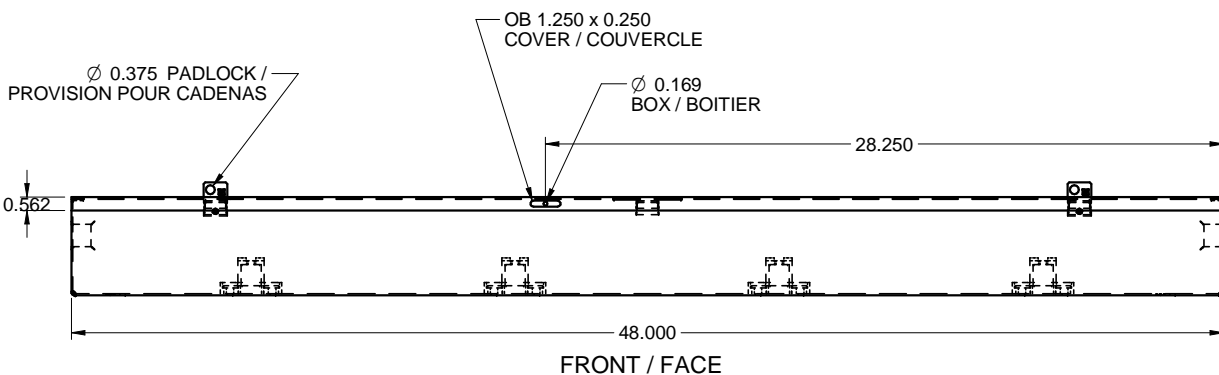

INSULATOR #BEL33
ISOLATEUR #BEL33