

TOP / DESSUS

R363012
STEEL / ACIER

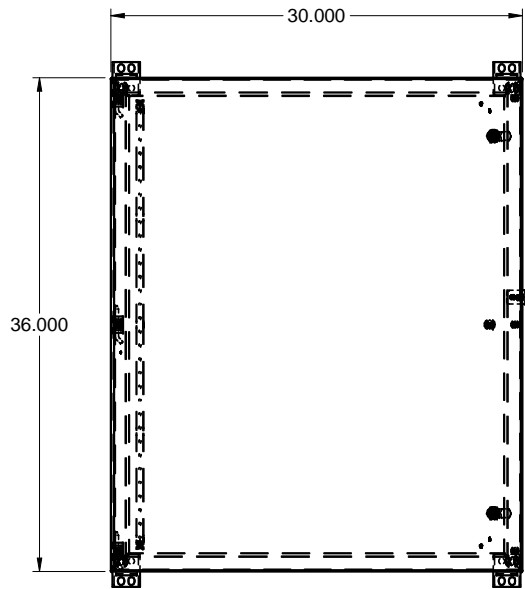

FRONT / FACE

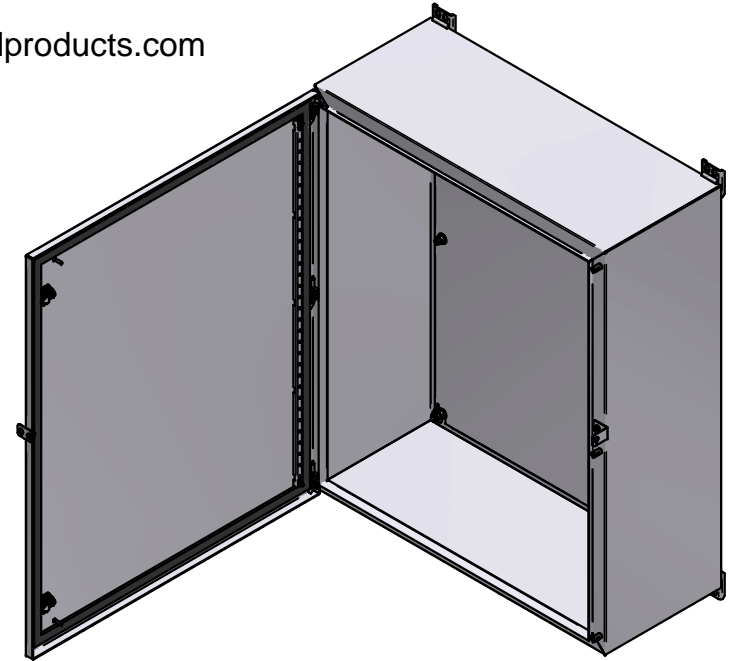
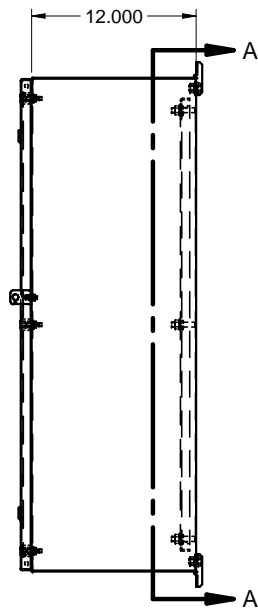

SIDE / CÔTÉ

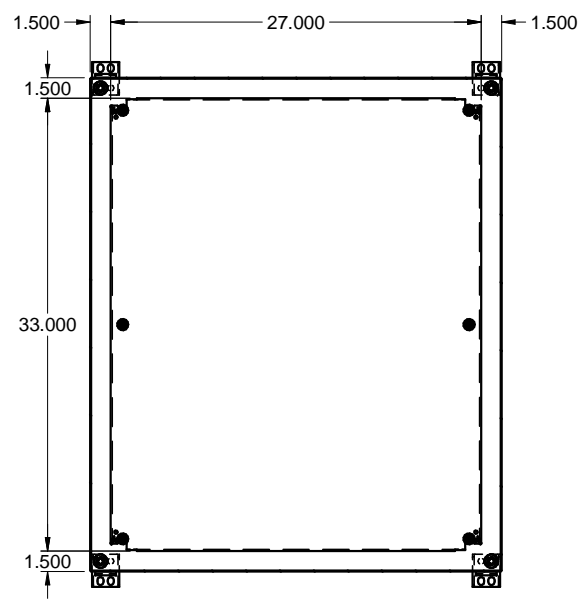

SECTION A-A

