

TOP / DESSUS

R302408 SS
STAINLESS STEEL /
ACIER INOXYDABLE

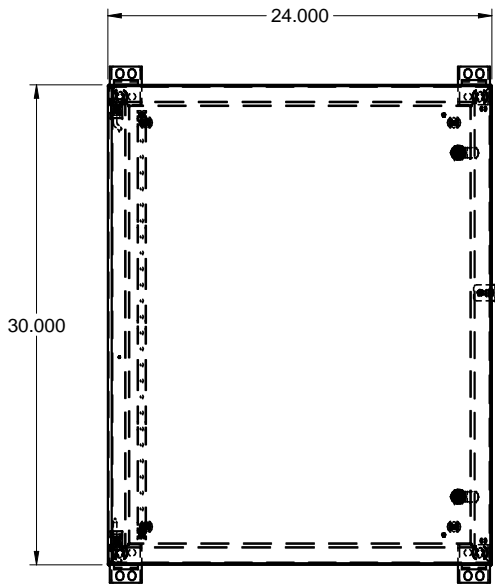

FRONT / FACE

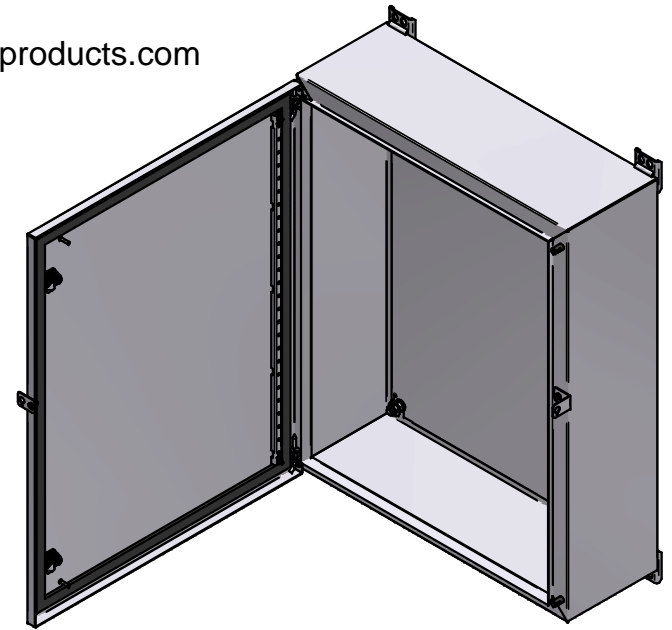
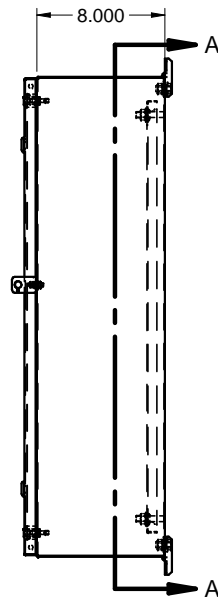

SIDE / CÔTÉ

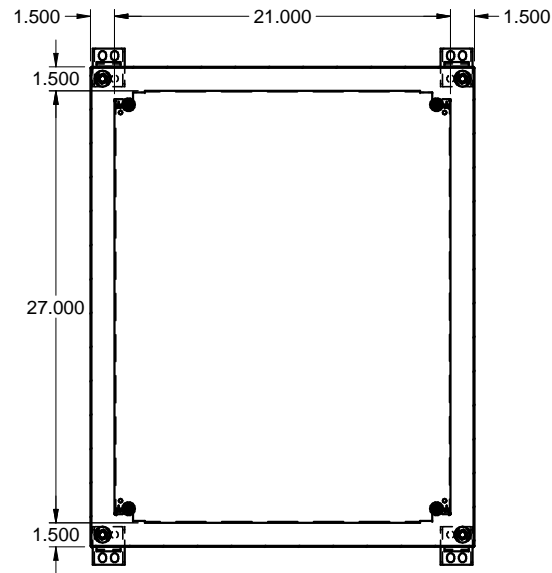

SECTION A-A

